

1-800-639-2199

Fax (603) 224-2927

Phoenix Precast Products Headwalls\Standard\Wing Walls\Dual 15 in_RCP_Wing Wall with Base (V)

Phoenix Precast Products

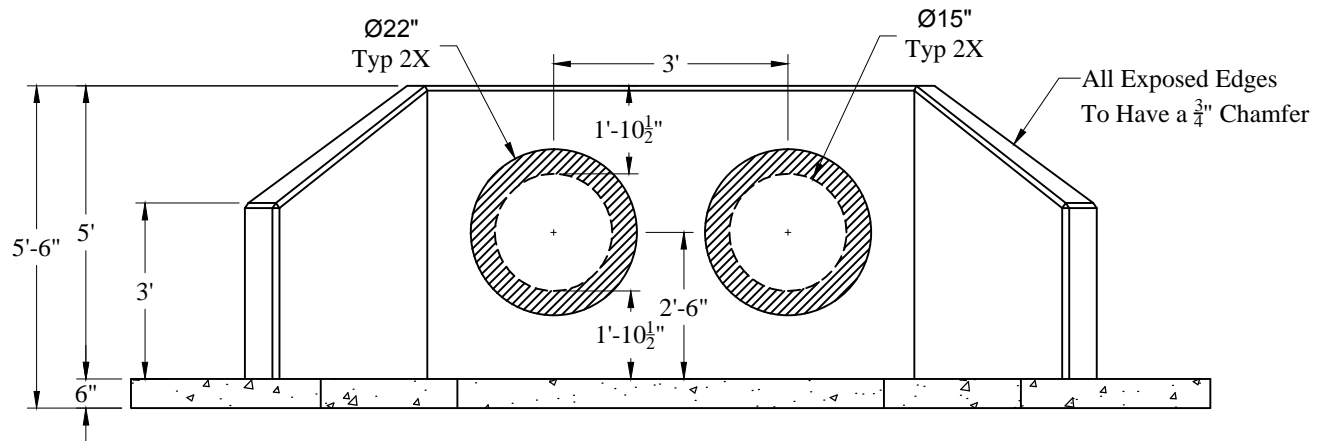
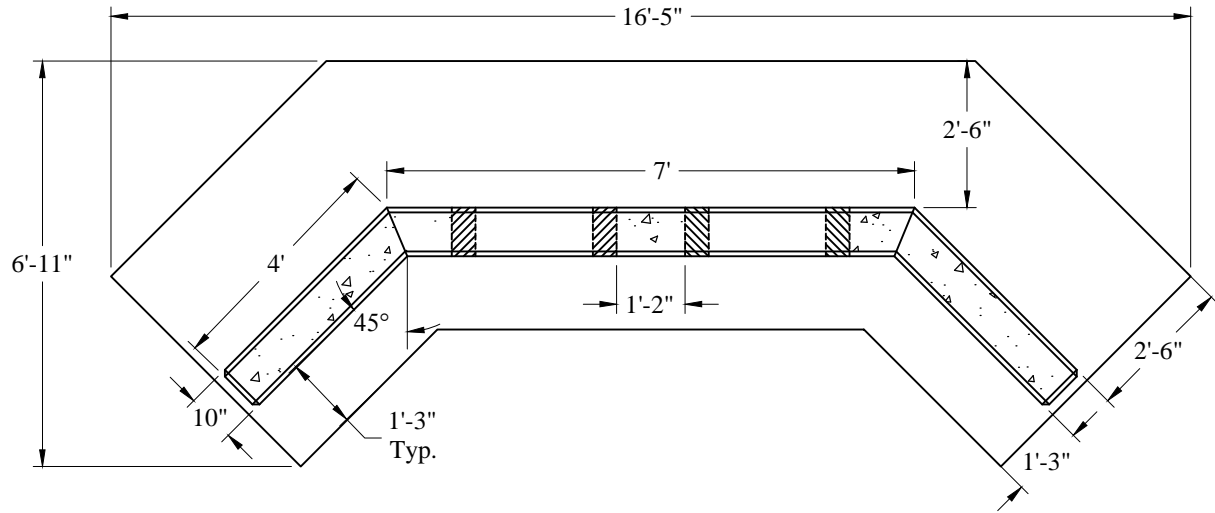

Est Weight: 12,900 Lbs

General Notes

1. Precast Concrete Shall Conform to AASHTO M 199. Concrete Shall be Class AAA ($f'c = 5000$ psi)
2. Reinforcing Steel Shall Conform to AASHTO M 31, ASTM A-615 Grade 60 Black Deformed Bars
3. All Exposed Corners to Have a $\frac{3}{4}$ " Chamfer

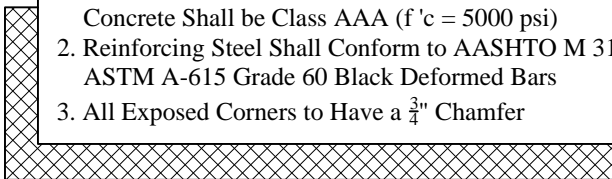

Not to Scale

Phoenix
Precast
Products

Dual 15" RCP
Winged Headwall
with Base

P/N: HWW-D15B